

TVS Diodes

Transient Voltage Suppression Diodes



Description

Transient Voltage Suppressor (TVS) is a circuit protection component that either attenuates (reduces) or filters a transient voltage spike (overvoltage), TVS diodes provide critical protection by going into avalanche breakdown within no more than a few nanoseconds after a strike, clamping the transient voltage, and routing its current to the ground.

Applications

- Communication Equipment
- Security & Protection
- Industrial Control Equipment
- Power Supply
- Automotive Electronics
- New Energy
- Lightning Protection

Functional Diagram

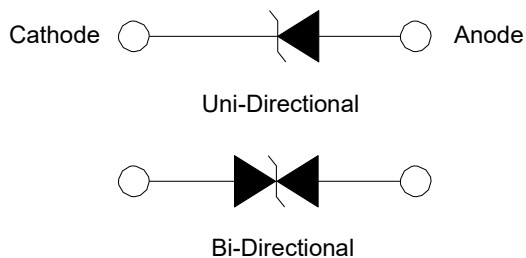

Features

- AEC-Q101 Qualified
- Low incremental surge resistance
- Excellent clamping capability
- Low profile package with built-in strain relief
- Typical I_R less than 1.0 μA above 12 V
- 600 W peak pulse power capability with a 10/1000 μs waveform, repetition rate (duty cycle): 0.01%
- For surface mounted applications to optimize board space
- Typical failure mode is short from over-specified voltage or current
- IEC 61000-4-2 ESD 30 kV (Air), 30 kV (Contact)
- EFT protection of data lines in accordance with IEC 61000-4-4
- Very fast response time
- Glass passivated chip junction
- High temperature to reflow soldering guaranteed: 260 $^{\circ}C/30$ sec
- $V_{BR} @ T_J = V_{BR@25^{\circ}C} \times (1 + \alpha T \times (T_J - 25))$
(αT : Temperature Coefficient, typical value is 0.1%)
- Plastic package is flammability rated V-0 per Underwriters Laboratories
- Meet MSL level1, per J-STD-020
- Matte tin lead-free plated
- Halogen free and RoHS compliant
- Pb-free E3 means 2nd level interconnect is Pb-free and the terminal finish material is tin(Sn) (IPC/JEDEC J-STD-609A.01)

TVS Diodes

Transient Voltage Suppression Diodes

ASMB-VR Series

Package Outline Dimensions (DO-214AA)

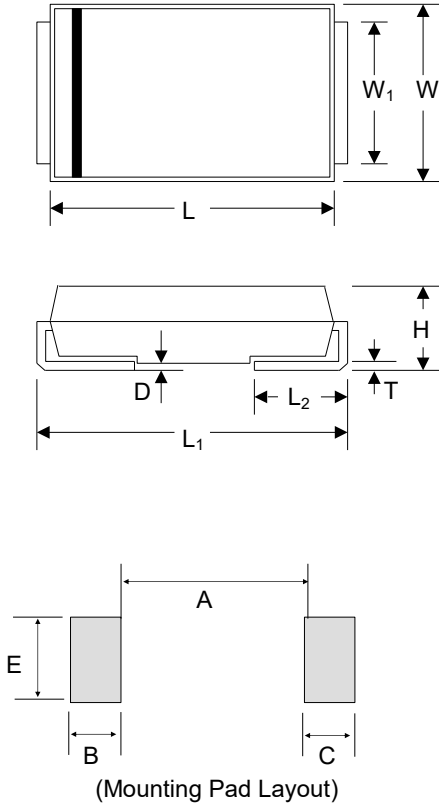

Symbol	Millimeters		Inches	
	Min.	Max.	Min.	Max.
L	4.06	4.75	0.160	0.187
W	3.30	3.94	0.130	0.155
W_1	1.93	2.20	0.076	0.086
H	1.99	2.61	0.078	0.103
T	0.152	0.305	0.006	0.012
L_1	5.21	5.59	0.205	0.220
L_2	0.76	1.52	0.030	0.060
D	-	0.203	-	0.008
A	-	2.74	-	0.107
B	2.16	-	0.085	-
C	2.16	-	0.085	-
E	2.26	-	0.089	-

Maximum Ratings and Characteristics

(Ratings at 25°C ambient temperature unless otherwise specified.)

Parameter	Symbol	Value	Unit
Peak Power Dissipation with a 10/1000 μ s waveform ⁽¹⁾⁽²⁾ (Fig.2)-Single Die Parts	P _{PPM}	600	W
Peak Power Dissipation with a 10/1000 μ s waveform ⁽¹⁾⁽²⁾ (Fig.2)-Stacked Die Parts ⁽⁵⁾	P _{PPM}	800	W
Peak Power Dissipation on Infinite Heat Sink at T _L =50 °C	P _D	5.0	W
Peak Forward Surge Current,8.3 ms single half sinewave superimposed on rated load (JEDEC Method) ⁽³⁾	I _{FSM}	100	A
Maximum Instantaneous Forward Voltage at 50 A for Unidirectional Only ⁽⁴⁾	V _F	3.5 / 5.0	V
Operating Temperature Range	T _J	-65 to 150	°C
Storage Temperature Range	T _{STG}	-65 to 175	°C
Typical Thermal Resistance Junction to Lead	R _{θJL}	20	°C / W
Typical Thermal Resistance Junction to Ambient	R _{θJA}	100	°C / W

Notes

1. Non-repetitive current pulse, per Fig. 4 and derated above T_J(initial)=25 °C per Fig. 3.
2. Mounted on 5.0 mm² land areas.
3. Measured of 8.3 ms single half sine-wave or equivalent square wave, duty cycle=4 pulses per minute maximum.
4. V_F < 3.5 V for single die parts and V_F< 5.0 V for stacked-die parts.
5. For stacked die component details, please refer to part numbers labeled by * in Electrical Characteristics.

TVS Diodes

Transient Voltage Suppression Diodes

ASMB-VR Series

Part Numbering System

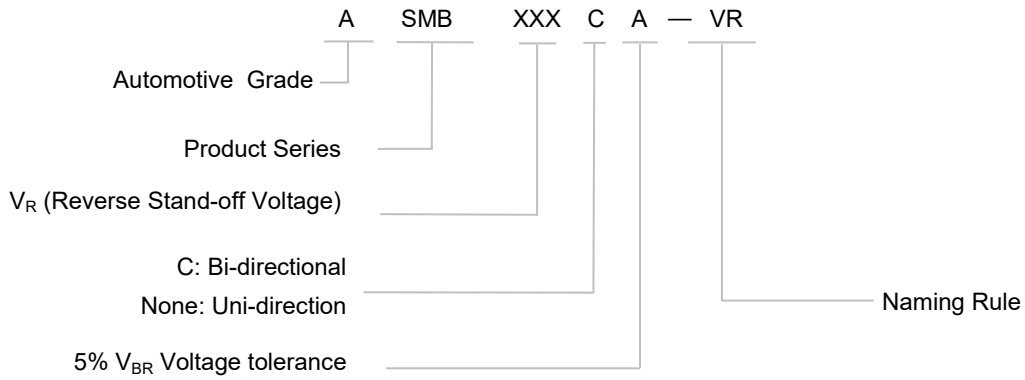

Marking

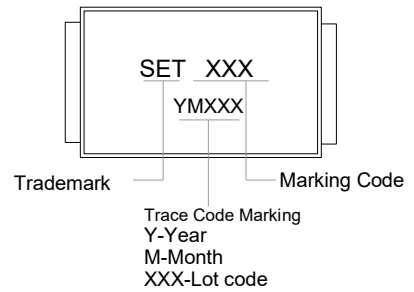
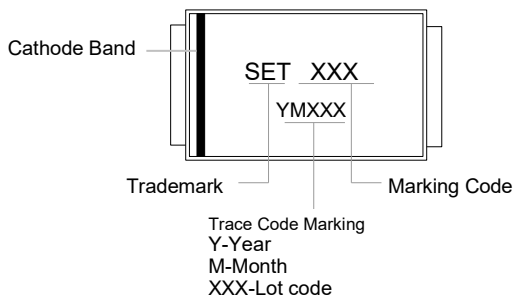

TVS Diodes

Transient Voltage Suppression Diodes

ASMB-VR Series

Electrical Characteristics ($T_A=25\text{ }^\circ\text{C}$ unless otherwise noted)Table 1

Part Number		Device Marking Code		Breakdown Voltage $V_{BR}@I_T$		Test Current I_T	Reverse Stand-off Voltage V_R	Max. Reverse Leakage $I_R@V_R$	Max. Peak Pulse Current I_{PPM}	Max. Clamping Voltage $V_C@I_{PPM}$
				Min	Max					
Uni	Bi	Uni	Bi	(V)		(mA)	(V)	(μ A)	(A)	(V)
ASMB5.0A-VR	ASMB5.0CA-VR	AKE	AAE	6.40	7.00	10	5.00	500.00	65.30	9.20
ASMB6.0A-VR	ASMB6.0CA-VR	AKG	AG	6.67	7.37	10	6.00	500.00	58.30	10.30
ASMB6.5A-VR	ASMB6.5CA-VR	AKK	AAK	7.22	7.98	10	6.50	300.00	53.60	11.20
ASMB7.0A-VR	ASMB7.0CA-VR	AKM	AAM	7.78	8.60	10	7.00	100.00	50.00	12.00
ASMB7.5A-VR	ASMB7.5CA-VR	AKP	AAP	8.33	9.21	1	7.50	100.00	46.60	12.90
ASMB8.0A-VR	ASMB8.0CA-VR	AKR	AAR	8.89	9.83	1	8.00	30.00	44.20	13.60
ASMB8.5A-VR	ASMB8.5CA-VR	AKT	AAT	9.44	10.40	1	8.50	20.00	41.70	14.40
ASMB9.0A-VR	ASMB9.0CA-VR	AKV	AAV	10.00	11.10	1	9.00	10.00	39.00	15.40
ASMB10A-VR	ASMB10CA-VR	AKX	AAX	11.10	12.30	1	10.00	5.00	35.30	17.00
ASMB11A-VR	ASMB11CA-VR	AKZ	AAZ	12.20	13.50	1	11.00	1.00	33.00	18.20
ASMB12A-VR	ASMB12CA-VR	ALE	ABE	13.30	14.70	1	12.00	1.00	30.20	19.90
ASMB13A-VR	ASMB13CA-VR	ALG	ABG	14.40	15.90	1	13.00	1.00	28.00	21.50
ASMB14A-VR	ASMB14CA-VR	ALK	ABK	15.60	17.20	1	14.00	1.00	25.90	23.20
ASMB15A-VR	ASMB15CA-VR	ALM	ABM	16.70	18.50	1	15.00	1.00	24.60	24.40
ASMB16A-VR	ASMB16CA-VR	ALP	ABP	17.80	19.70	1	16.00	1.00	23.10	26.00
ASMB17A-VR	ASMB17CA-VR	ALR	ABR	18.90	20.90	1	17.00	1.00	21.80	27.60
ASMB18A-VR	ASMB18CA-VR	ALT	ABT	20.00	22.10	1	18.00	1.00	20.60	29.20
ASMB20A-VR	ASMB20CA-VR	ALV	ABV	22.20	24.50	1	20.00	1.00	18.60	32.40
ASMB22A-VR	ASMB22CA-VR	ALX	ABX	24.40	26.90	1	22.00	1.00	16.90	35.50
ASMB24A-VR	ASMB24CA-VR	ALZ	ABZ	26.70	29.50	1	24.00	1.00	15.50	38.90
ASMB26A-VR	ASMB26CA-VR	AME	ACE	28.90	31.90	1	26.00	1.00	14.30	42.10
ASMB28A-VR	ASMB28CA-VR	AMG	ACG	31.10	34.40	1	28.00	1.00	13.30	45.40
ASMB30A-VR	ASMB30CA-VR	AMK	ACK	33.30	36.80	1	30.00	1.00	12.40	48.40
ASMB33A-VR	ASMB33CA-VR	AMM	ACM	36.70	40.60	1	33.00	1.00	11.30	53.30
ASMB36A-VR	ASMB36CA-VR	AMP	ACP	40.00	44.20	1	36.00	1.00	10.40	58.10
ASMB40A-VR	ASMB40CA-VR	AMR	ACR	44.40	49.10	1	40.00	1.00	9.30	64.50
ASMB43A-VR	ASMB43CA-VR	AMT	ACT	47.80	52.80	1	43.00	1.00	8.70	69.40
ASMB45A-VR	ASMB45CA-VR	AMV	ACV	50.00	55.30	1	45.00	1.00	8.30	72.70
ASMB48A-VR	ASMB48CA-VR	AMX	ACX	53.30	58.90	1	48.00	1.00	7.80	77.40
ASMB51A-VR	ASMB51CA-VR	AMZ	ACZ	56.70	62.70	1	51.00	1.00	7.30	82.40
ASMB54A-VR	ASMB54CA-VR	ANE	ADE	60.00	66.30	1	54.00	1.00	6.90	87.10

TVS Diodes

Transient Voltage Suppression Diodes

ASMB-VR Series

Part Number		Device Marking Code		Breakdown Voltage $V_{BR}@I_T$		Test Current I_T	Reverse Stand-off Voltage V_R	Max. Reverse Leakage $I_R@V_R$	Max. Peak Pulse Current I_{PPM}	Max. Clamping Voltage $V_C@I_{PPM}$
				Min	Max					
Uni	Bi	Uni	Bi	(V)		(mA)	(V)	(μ A)	(A)	(V)
ASMB58A-VR	ASMB58CA-VR	ANG	ADG	64.40	71.20	1	58.00	1.00	6.50	93.60
ASMB60A-VR	ASMB60CA-VR	ANK	ADK	66.70	73.70	1	60.00	1.00	6.20	96.80
ASMB64A-VR	ASMB64CA-VR	ANM	ADM	71.10	78.60	1	64.00	1.00	5.90	103.00
ASMB70A-VR	ASMB70CA-VR	ANP	ADP	77.80	86.00	1	70.00	1.00	5.30	113.00
ASMB75A-VR	ASMB75CA-VR	ANR	ADR	83.30	92.10	1	75.00	1.00	5.00	121.00
ASMB78A-VR	ASMB78CA-VR	ANT	ADT	86.70	95.80	1	78.00	1.00	4.80	126.00
ASMB85A-VR	ASMB85CA-VR	ANV	ADV	94.40	104.00	1	85.00	1.00	4.40	137.00
ASMB90A-VR	ASMB90CA-VR	ANX	ADX	100.00	111.00	1	90.00	1.00	4.10	146.00
ASMB100A-VR	ASMB100CA-VR	ANZ	ADZ	111.00	123.00	1	100.00	1.00	3.70	162.00
ASMB110A-VR	ASMB110CA-VR	APE	AEE	122.00	135.00	1	110.00	1.00	3.40	177.00
ASMB120A-VR	ASMB120CA-VR	APG	AEG	133.00	147.00	1	120.00	1.00	3.10	193.00
ASMB130A-VR	ASMB130CA-VR	APK	AEK	144.00	159.00	1	130.00	1.00	2.90	209.00
ASMB150A-VR	ASMB150CA-VR	APM	AEM	167.00	185.00	1	150.00	1.00	2.50	243.00
ASMB160A-VR	ASMB160CA-VR	APP	AEP	178.00	197.00	1	160.00	1.00	2.30	259.00
ASMB170A-VR	ASMB170CA-VR	APR	AER	189.00	209.00	1	170.00	1.00	2.20	275.00
ASMB180A-VR	ASMB180CA-VR	APT	AET	201.00	222.00	1	180.00	1.00	2.10	292.00
ASMB188A-VR	ASMB188CA-VR	APB	AEB	209.00	231.00	1	188.00	1.00	2.00	304.00
ASMB200A-VR	ASMB200CA-VR	APV	AEV	224.00	247.00	1	200.00	1.00	1.90	324.00
ASMB220A-VR	ASMB220CA-VR	APX	AEX	246.00	272.00	1	220.00	1.00	1.70	356.00
ASMB250A-VR	ASMB250CA-VR	APZ	AEZ	279.00	309.00	1	250.00	1.00	1.50	405.00
ASMB300A*-VR	ASMB300CA*-VR	AQE	AFE	335.00	371.00	1	300.00	1.00	1.30	486.00
ASMB350A*-VR	ASMB350CA*-VR	AQG	AFG	391.00	432.00	1	350.00	1.00	1.10	567.00
ASMB400A*-VR	ASMB400CA*-VR	AQK	AFK	447.00	494.00	1	400.00	1.00	0.90	648.00
ASMB440A*-VR	ASMB440CA*-VR	AQM	AFM	492.00	543.00	1	440.00	1.00	0.90	713.00

Notes:

1. For bidirectional type having V_R of 10 volts and less, the I_R should be doubled.
2. For parts without A in the PN, the V_{BR} tolerance is $\pm 10\%$ and V_C is 5% higher than parts with A. The parts without A are currently available, but not recommended for new designs. The parts with A are preferred.
3. For stacked die component details, please refer to models marked with * in electrical characteristics table.

TVS Diodes

Transient Voltage Suppression Diodes

ASMB-VR Series

I-V Curve Characteristics

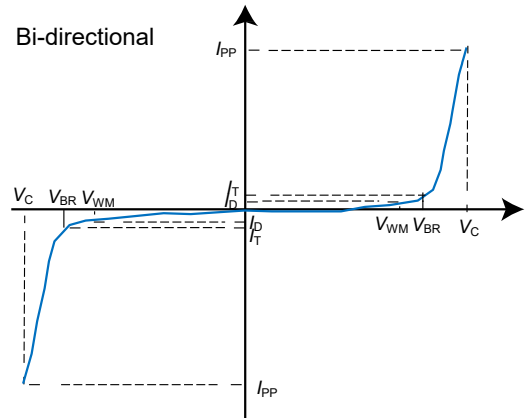
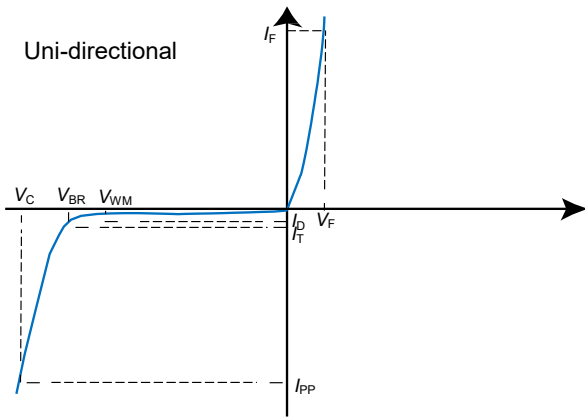

Performance Curve for Reference ($T_A=25^\circ\text{C}$ unless otherwise noted)

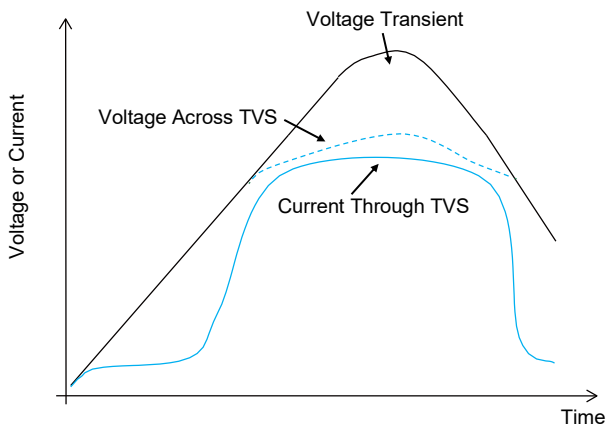

FIGURE 1 TVS Transients Clamping Waveform

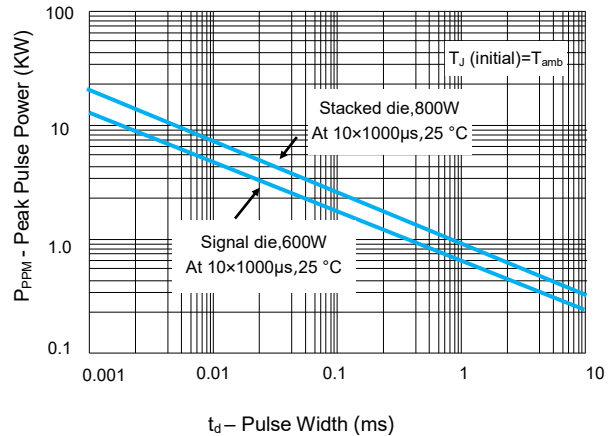

FIGURE 2 Peak Pulse Power Rating Curve

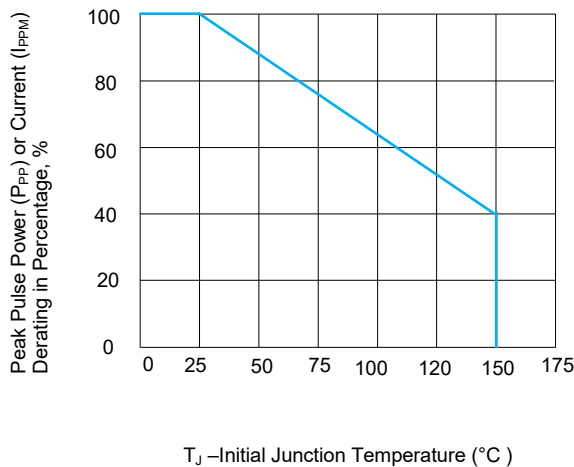

FIGURE 3 Peak Pulse Power Derating Curve

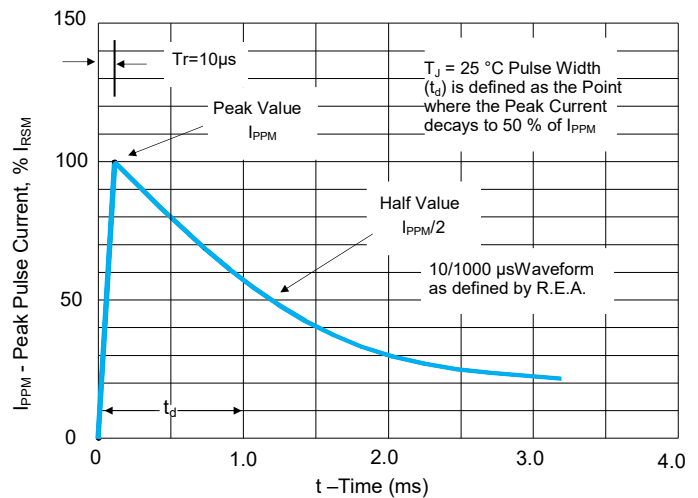

FIGURE 4 Pulse Waveform

TVS Diodes

Transient Voltage Suppression Diodes

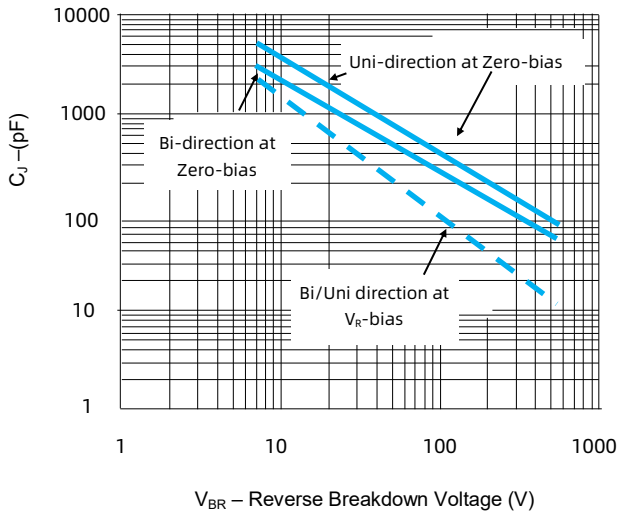

FIGURE 5 Typical Junction Capacitance

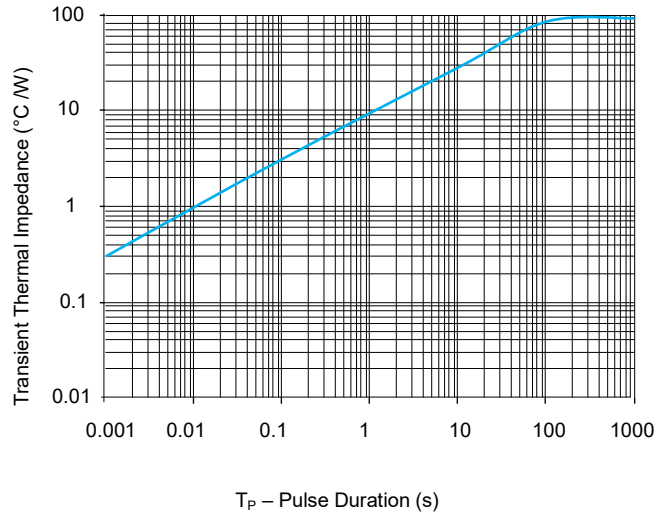

FIGURE 6 Typical Transient Thermal Impedance

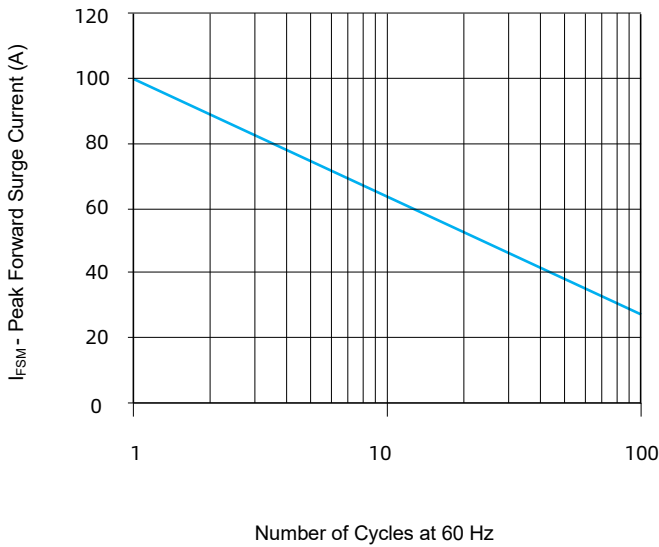

FIGURE 7 Maximum Non-Repetitive Forward Surge Current Uni-Directional only

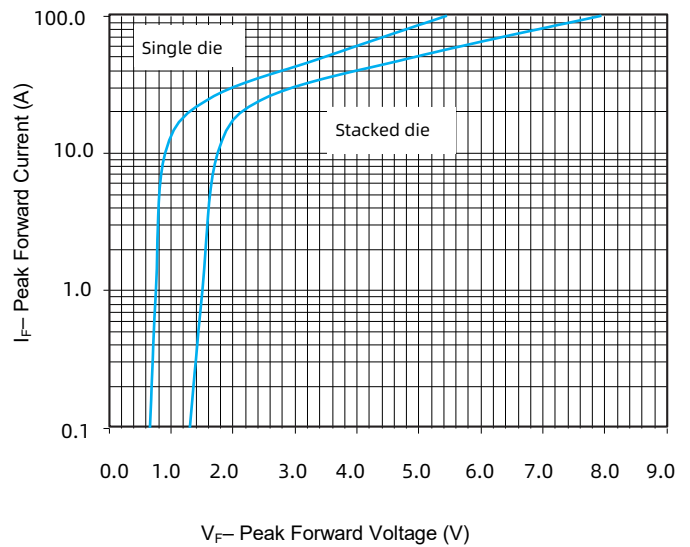

FIGURE 8 Peak Forward Drop vs Peak Forward Current (Typical Values)

Environmental Specifications

High Temp. Storage	JESD22-A103
HTRB	JESD22-A108
Temperature Cycling	JESD22-A104
MSL	JESDEC-J-STD-020, Level 1
H3TRB	JESD22-A101
RSH	JESD22-A111

Physical Specifications

Weight	0.003 ounce, 0.093 grams
Case	JESD22DO214AA. Molded plastic body over glass passivated junction
Polarity	Color band denotes positive end (cathode) except Bidirectional
Terminal	Matte Tin-plated leads, Solderability per JESD22-B102

Soldering Parameters

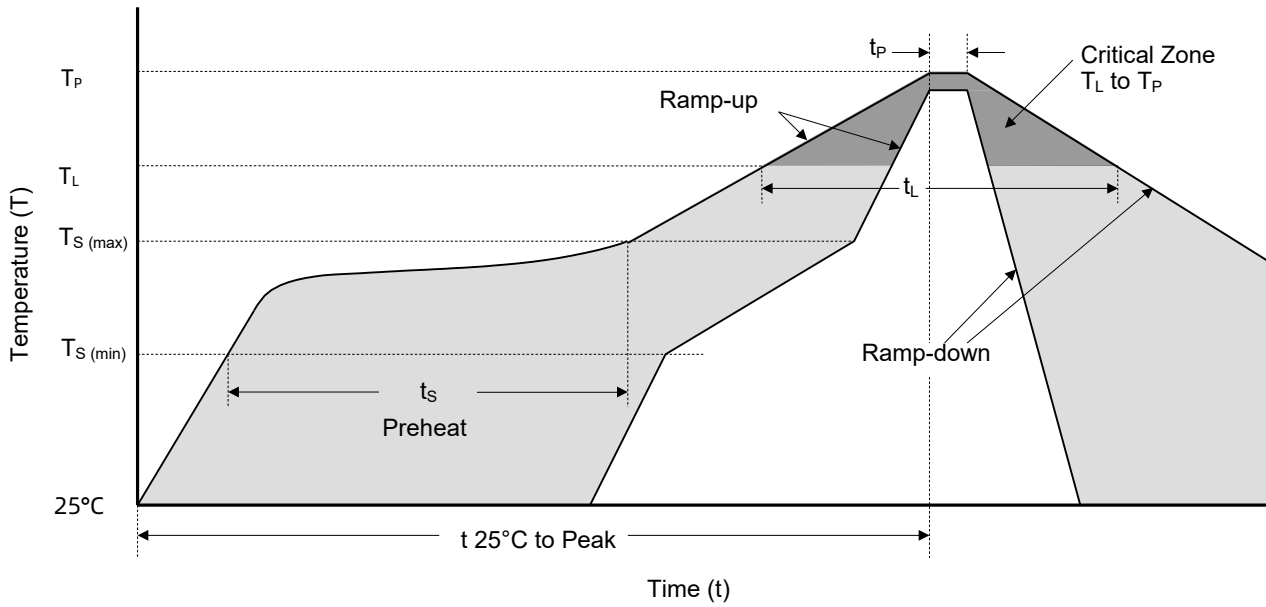

Reflowing Condition

Reflow Soldering Parameters		Lead-Free Assembly
Pre-heat	Temperature Min ($T_{S (min)}$)	150 °C
	Temperature Max ($T_{S (max)}$)	200 °C
	Time (min to max) (t_s)	60 ~ 120 seconds
Average Ramp Up Rate (Liquidus Temp (T_L) to Peak)		3 °C / second max.
$T_{S (max)}$ to T_L Ramp-up Rate		3 °C / second max.
Reflow	Temperature (T_L) (Liquidus)	217 °C
	Time (min to max) (t_L)	60 ~ 150 seconds
Peak Temperature (T_P)		260 ^{+0/-5} °C
Time of within 5 °C of Actual Peak Temperature (t_p)		20 ~ 40 seconds
Ramp-down Rate		6 °C / second max.
Time from 25 °C to Peak Temperature		8 Minutes max.
Do Not Exceed		260 °C

TVS Diodes

Transient Voltage Suppression Diodes

ASMB-VR Series

Packaging Information

Tape	Symbol	Dimension (mm)
	W	12.00+0.30/-0.10
	P ₀	4.00±0.10
	P ₁	8.00±0.10
	P ₂	2.00±0.05
	D ₀	1.55±0.05
	D ₁	1.55±0.05
	E	1.75±0.10
	F	5.50±0.05
	A ₀	3.78±0.10
	B ₀	5.65±0.15
	K ₀	2.70±0.10
	T	0.30±0.05

Reel Size	13" Reel	
	A	330 mm
	C	13.2 mm
	W ₁	12.5 mm

Part Number	Package	QTY (Reel)	Packaging Option	Packaging Specification
ASMBxxx-VR	DO-214AA	3000 PCS	Tape & Reel – 12 mm tape/13" reel	EIA STD RS-481

Glossary

Item	Description
V_C	Clamping Voltage Voltage across TVS in a region of low differential resistance that serves to limit the voltage across the device terminals.
V_R	Reverse Stand-off Voltage Maximum voltage that can be applied to the TVS without operation. NOTE : It is also shown as V_{WM} (maximum working voltage (maximum d.c. voltage)) and known as rated stand-off voltage (V_{SO}).
I_R	Reverse Leakage Current Current measured at V_R . NOTE : Also shown as I_D for stand-by current.
V_{BR}	Breakdown Voltage Voltage across TVS at a specified current I_T in the breakdown region.
I_{PPM}	Rated Random Recurring Peak Impulse Current Maximum-rated value of random recurring peak impulse current that may be applied to a device.
$P_{M(AV)}$	Rated Average Power Dissipation Maximum-rated value of power dissipation resulting from all sources, including transients and standby current, averaged over a short period of time.
P_{PPM}	Rated Random Recurring Peak Impulse Power Dissipation Maximum-rated value of the product of rated random recurring peak impulse current (I_{PPM}) multiplies by specified maximum clamping voltage (V_C).
C_J	Capacitance Capacitance across the TVS measured at a specified frequency and voltage.
V_{FS}	Peak Forward Surge Voltage Peak voltage across an TVS for a specified forward surge current (I_{FS}) and time duration. NOTE : Also shown as V_F .
I_{FS}	Forward Surge Current Pulsed current through TVS in the forward conducting region. NOTE : Also shown as I_F .
$\alpha_{V(BR)}$	Temperature Coefficient of Breakdown Voltage The change of breakdown voltage divided by the change of temperature.
I_{PP}	Peak pulse Current Peak pulse current value applied across the TVS to determine the clamping voltage V_C for a specified wave shape.
I_T	Pulsed D.C. Test Current Test current for measurement of the breakdown voltage V_{BR} . This is defined by the manufacturer and usually given in milliamperes with a pulse duration of less than 40 ms. NOTE : Also shown as I_{BR} .

—(GB-T 18802.321 / IEC 61643-321 / JESD210A)



ATTENTION

Usage

1. TVS must be operated in the specified ambient temp.
2. Do not clean the TVS with strong polar solvent such as ketone, esters, benzene and halogenated hydrocarbon, to avoid damaging the encapsulating layer.
3. Please do not apply severe vibration, shock or pressure to TVS, to avoid element cracking.

Replacement

1. If TVS is visually damaged, please replace it.
2. TVS is a non-repairable product. For safety sake, please use equivalent TVS for replacement.

Storage

1. Storage Temp. Range: (-55 to 150) °C.
2. Do not store the TVS at the high temp., high humidity or corrosive gas environment, to avoid influencing the solder-ability of the lead wires. The product shall be used up within 1 year after receiving the goods.

Environmental Conditions

1. TVS should not be exposed to the open air, nor direct sunshine.
2. TVS should avoid rain, water vapor or other condition of high temp. and high humidity.
3. TVS should avoid sand dust, salt mist, or other harmful gases.

Max. Typical Capacitance of TVS

The typical capacitance of TVS is listed in the specifications. Designers may refer to it when designing TVS in High frequency circuit.

Installation Mechanical Stress

1. Do not knock TVS when installing, to avoid mechanical damage.
2. Please do not apply severe vibration, shock or pressure to TVS, to avoid surface resin or element cracking.

Automotive TVS Diodes (Surface Mount) Feature Overview

Package Type	Series													
	DO-214AA	DO-214AB	DO-214AC	DO-218AB	ASMB	ASMB-VR	ASMC	ASMC-VR	ASMD	A5.0SMD	SM8SxxA	SM8SxxCA	SM8TxxA	SM8TxxCA
Product Outline (mm)														
V_R / V_{WM} (V) Reverse Stand-off Voltage	5.8 ~ 468	5.0 ~ 440	5.8 ~ 553	5.0 ~ 440	5.8 ~ 553	5.0 ~ 440	5.8 ~ 51	5.0 ~ 440	12.0 ~ 170	10.0 ~ 43.0	12.0 ~ 43.0	20.0 ~ 43.0	33.0 ~ 36.0	
P_{PPM} (W) (10/1000 μ s) Rated Peak Impulse Power Dissipation	400	600	1500	3000	5000	6600	8000							
Operating Temperature (°C)	-55 to +150						-55 to +175							